

# STONE CAST INC.

2300 KARBACH "B" HOUSTON TX 77092

Office: 713-683-6780 \* Fax: 713-683-6749 \* www.houstonstonecast.com

# FLORENZA 8" HEADER STRAIGHT

SCALE AS NOTED

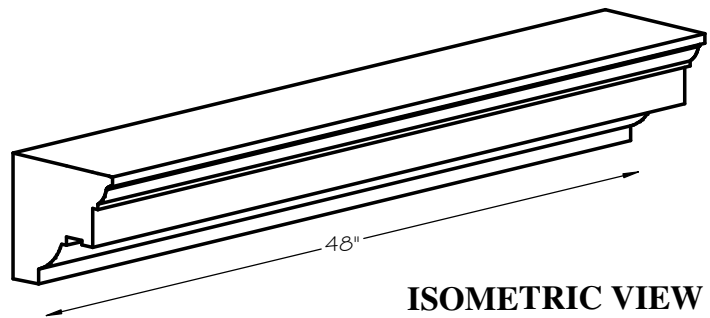
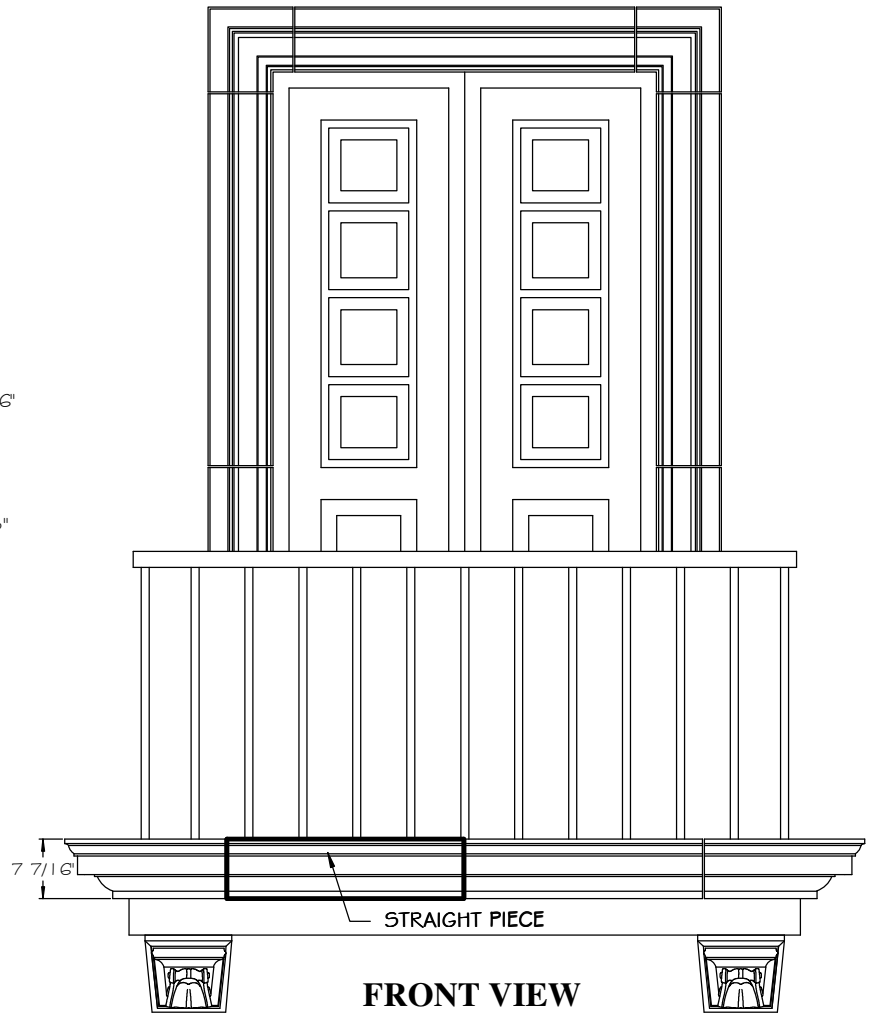
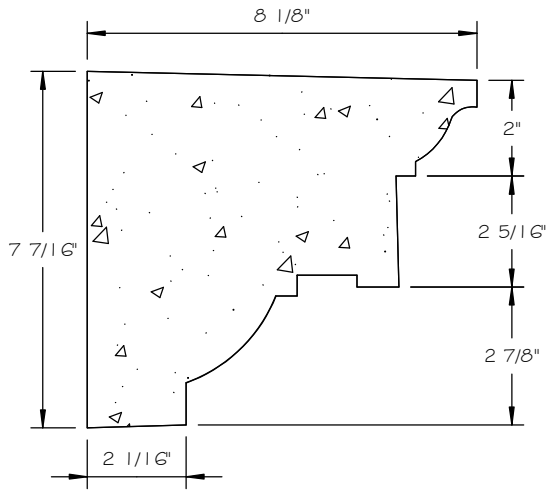

## STANDARD DIMENSIONS AVAILABLE

SIZE	ITEM #
3 1/2" x 60"L	F03-3.5
4" x 48"L	F03-04
8" x 48"L	F03-08

## 8" FLORENZA HEADER STRAIGHT

ITEM # F03-08

FOR STUCCO APPLICATIONS