

STONE CAST INC.

2300 KARBACH "B" HOUSTON TX 77092

Office: 713-683-6780 * Fax: 713-683-6749 * www.houstonstonecast.com

FLORENZA 9" SILL STRAIGHT

SCALE AS NOTED

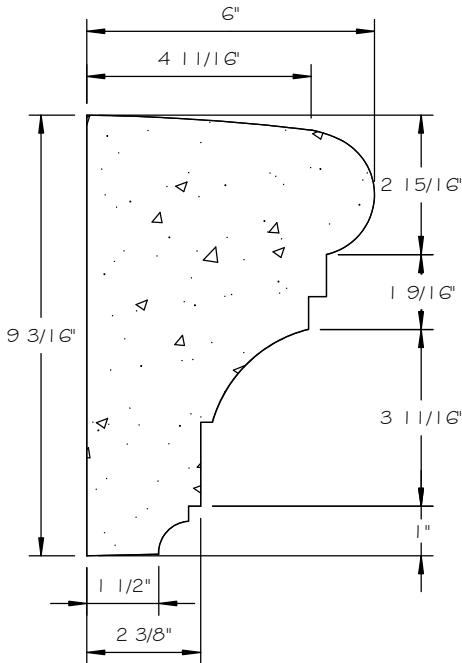

SECTION

SCALE 3" = 1' 0"

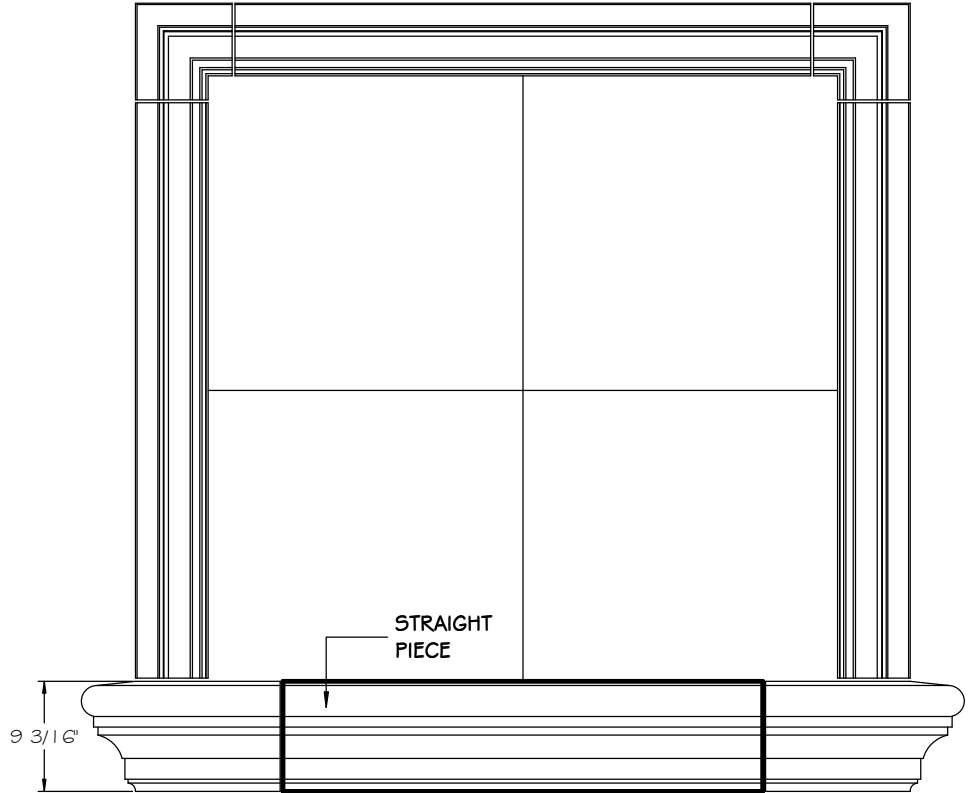

FRONT VIEW

SCALE 3/4" = 1' 0"

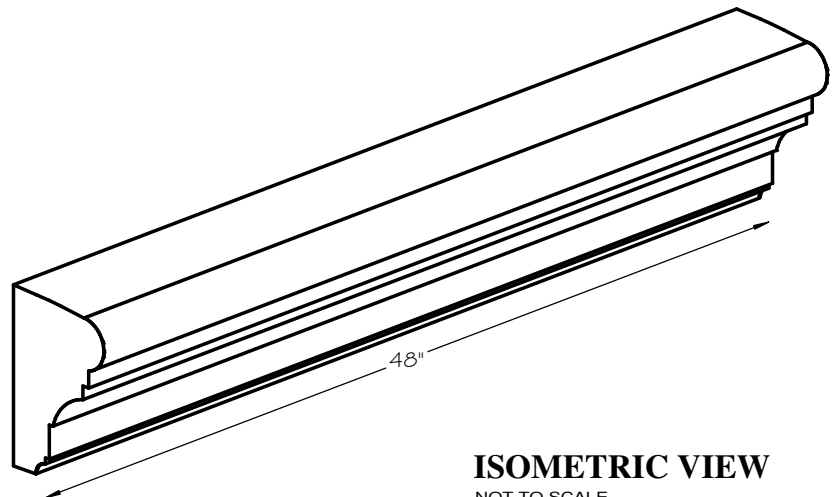

ISOMETRIC VIEW

NOT TO SCALE

STANDARD DIMENSIONS AVAILABLE

SIZE	ITEM #
9" x 48"L	D03-09
10" x 48"L	D03-10

9" FLORENZA SILL STRAIGHT

ITEM # D03-09

FOR STUCCO APPLICATIONS